

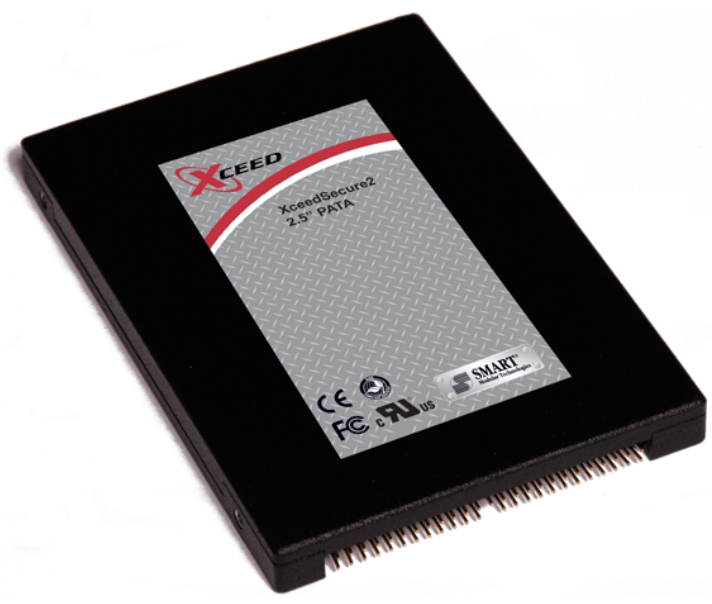

SMART Storage Products

Product Specification

Adtron XceedSecure2 PATA Solid State Drive



2.5" Data Storage

October 2009, Rev D
PN: 810100017-1N



www.smartm.com
www.adtron.com

REVISION HISTORY

Date	Revision	Section(s)	Description
Mar 2009	A	All	Prepared for release.
Apr 2009	B	Secure Erase	Added sentence regarding the use of an external trigger or software to initiate the secure erase operation.
Jun 2009	C	PATA Bus Characteristics	Added driver sink and source current information.
Oct 2009	D	Power and ATA Commands	Added average and rms values for all capacities; specified commands the drive blocks when write protect is enabled.



ESD Caution – Handling

Static electricity may be discharged through this disk subsystem. In extreme cases, this may temporarily interrupt the operation or damage components. To prevent this, make sure you are working in an ESD-safe environment. For example, before handling the disk subsystem, touch a grounded device, such as a computer case, prior to handling.

SMART Modular Technologies

Adtron Design Center
4415 E. Cotton Center Blvd.
Phoenix, AZ 85040
602-735-0300 voice
602-735-0349 fax
fre-sales-phx@smartm.com
An ISO 9001 certified company.

© 2009 SMART Modular Technologies. All rights reserved.

All trademarks are the property of their respective owners.

The information contained in this document is subject to change without notice and does not represent or imply warrant, and no liability is assumed by SMART Modular Technologies.

Where listed for specific models, performance characteristics for other models may differ.

One gigabyte, or GByte, equals one billion bytes when referring to drive capacity. Accessible capacity may vary based on the operating environment and drive formatting.



America



TABLE OF CONTENTS

1.0	Introduction	2	4.2	Operating Environment	9
1.1	Product Description.....	2	4.3	Shock and Vibration	10
1.2	Key Features.....	2	4.4	Regulations.....	10
1.3	Block Diagram	3	5.0	Drive Configuration	11
1.4	Optional Features	4	5.1	Pin Configurations	11
2.0	Product Specifications	4	5.1.1	J1 Jumper Settings	11
2.1	Physical Characteristics	4	5.1.2	JP1 Jumper Settings	12
2.2	Interface	6	5.2	Signal Connector Pinout	13
2.3	Performance.....	6	5.3	Signal Descriptions	14
2.3.1	Sustained and Random Performance	6	6.0	Supported ATA Commands	15
2.3.2	Access/Startup Times	6	7.0	Supported S.M.A.R.T. Operations	17
2.4	Capacity	7	8.0	Supported Secure Erase Standards	19
2.5	PATA Bus Characteristics.....	7	9.0	Ordering Information	20
2.6	Supply Voltage.....	8	10.0	Related Documents	20
2.7	Power Consumption	8	11.0	Contact Information	21
3.0	Reliability Characteristics	9			
4.0	Environmental Specifications	9			
4.1	Temperature.....	9			

1.0 INTRODUCTION

This product specification defines the architecture, attributes, performance, technologies, and compliance and regulatory requirements for the XceedSecure2 2.5" PATA data storage drive.

1.1 Product Description

The XceedSecure2 2.5" PATA data storage drive is powered by the patented ArrayPro[®] performance engine to deliver a high-performance solution for a wide range of applications. The XceedSecure2 2.5" PATA solid state drive (SSD) leverages this unique ArrayPro technology to provide true sustained write and read performance.

These 2.5-inch flash SSDs can easily replace standard 2.5-inch hard disk drives (HDDs), providing full HDD functionality with higher reliability and superior performance. In addition, the XceedSecure2 2.5" PATA SSD contains no moving parts. The XceedSecure2 2.5" PATA SSD is far superior to HDDs in terms of ruggedness, shock resistance, environmental resilience, and performance in no-compromise applications.

To meet the unique data security requirements of defense and security applications, EraSure[®] data security provides multiple levels of data elimination techniques. EraSure Clear provides a fast data elimination function that enables erasing of data in seconds. EraSure Sanitize uses an agency-defined and unique customer-defined pre-programmed sanitization procedure, allowing full media declassification. Combined with the ArrayPro performance engine, EraSure Sanitize delivers unparalleled secure erase performance.

1.2 Key Features

- High capacity in a 2.5" form factor; up to 128 GBytes in 9.5 mm
- High performance
 - ◆ **Burst:** 100 MBytes/sec
 - ◆ **Sustained Read:** Up to 70 MBytes/sec ¹
 - ◆ **Sustained Write:** Up to 45 MBytes/sec
 - ◆ **Access time:** < 1 msec
- ATA-7, UDMA 100 interface standard
- High reliability with single-level cell (SLC) flash
 - ◆ **Mean Time Between Failure:** 1,300,000 hours ²
 - ◆ **Non-Operating Shock:** 1500 g, half-sine, 0.5 ms, 1 shock along each axis: X, Y, and Z
 - ◆ **Operating Shock:** 50 g half-sine, 11 ms, 3 shocks along each axis: X, Y, and Z
 - ◆ **Operating Vibration:** Tested with the following categories: 12 for jets; 13 for propeller aircraft; 14 for helicopters; and 20 for ground vehicles
 - ◆ **Commercial Operating Temperature:** 0°C to 70°C
 - ◆ **Industrial Operating Temperature:** -40°C to 85°C
 - ◆ **Data Retention:** 10 years at 25°C

¹ Sustained performance numbers are calculated using a 128 GByte drive with 128 KByte transfers.

² Calculated using a 64 GByte drive. Based on Telcordia, Ground Benign Controlled at 25°C.

- Superior flash management
 - ♦ Error Correction Code (ECC)/Error Detection Code (EDC) - up to 4 bytes correction/5 bytes detection in a 512-byte sector
 - ♦ Static Wear Leveling
 - ♦ Bad Block Management
 - ♦ > 260 years @ 200 GBytes/day (64 GByte drive)³
- Three-year limited warranty

1.3 Block Diagram

Figure 1: XceedSecure2 2.5" PATA SSD Block Diagram

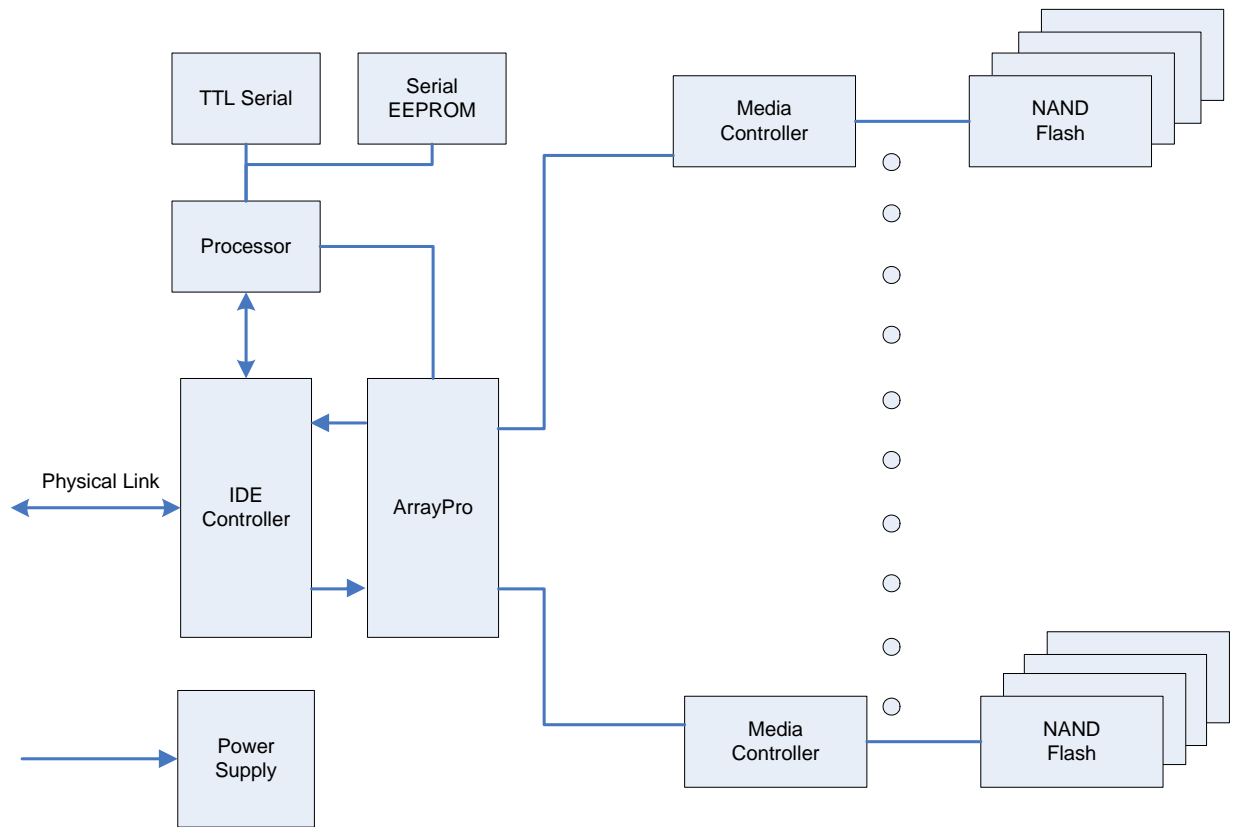

³ Based on 128 KByte block transfers and continuous, sequential writes to the drive. The number does not include file system overhead, which may vary depending on the file system. The total life span of the drive depends on both the write endurance numbers and MTBF. One kilobyte, or KByte, is equal to 1024 bytes.

1.4 Optional Features

- Conformal Coating
- BGA Underfill

2.0 PRODUCT SPECIFICATIONS

2.1 Physical Characteristics

The following table describes the XceedSecure2 2.5" PATA SSD dimensions, with the maximum weight. For detailed mounting configurations, see [Figure 2](#).

Table 1: Physical Dimensions

Parameter	Model	Value (Max)
Height	All	9.50 mm [0.37"]
Depth	All	100.20 mm [3.95"]
Width	All	69.85 mm [2.75"]
Weight	I25FBS-128G33N	104.80 g [3.70 oz]

Figure 2: XceedSecure2 2.5" PATA SSD Physical Dimensions (in mm [inches])

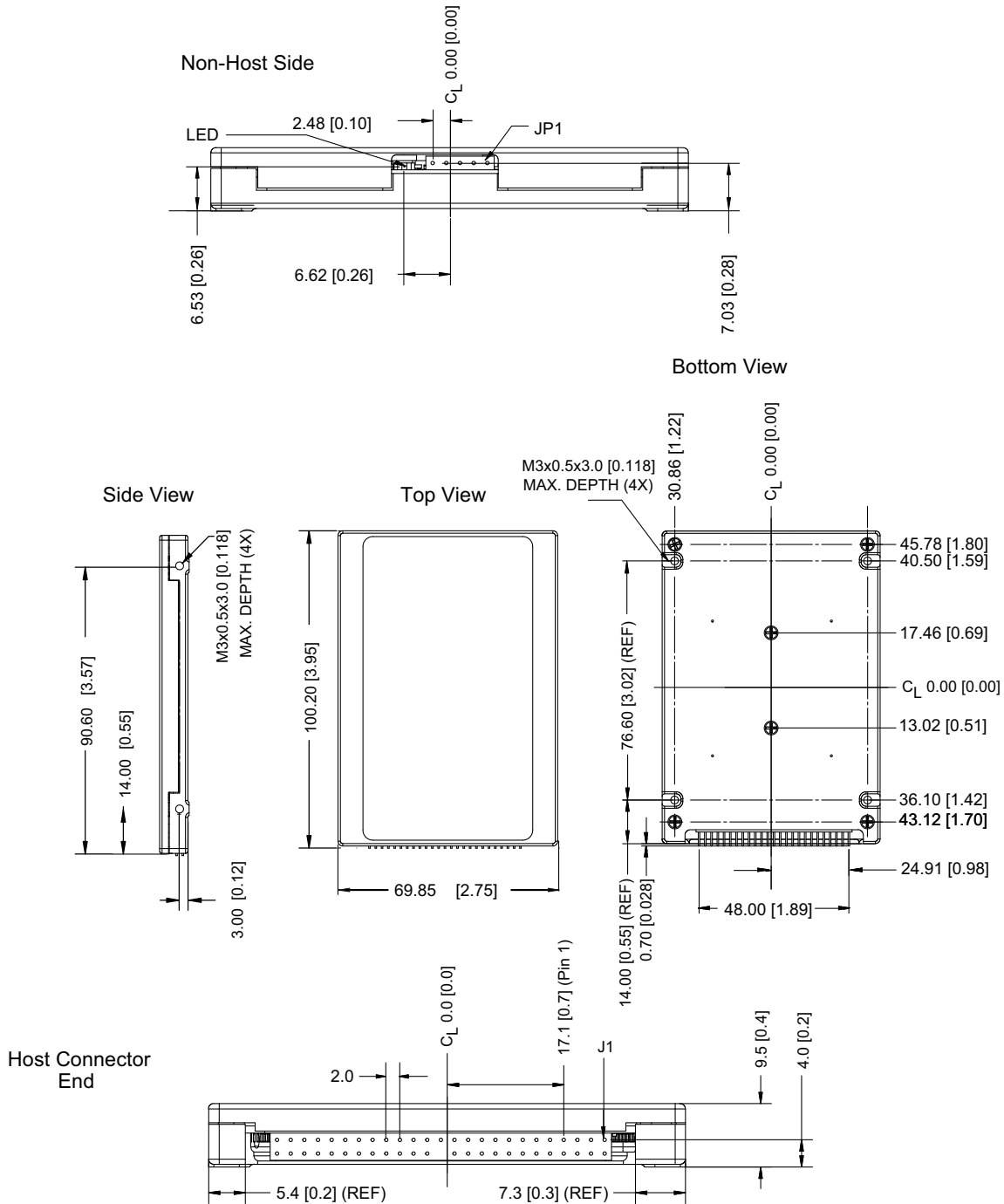

Mounting and Interconnect Dimensions Comply with ANSI/EIA-720-1997 EIA Specification for Small Form Factor 63.5 mm (2.5-inch) Disk Drives.

2.2 Interface

The XceedSecure2 2.5" PATA SSD supports ATA modes of operation, as shown in Table 2, and complies with the ATA/ATAPI-7; ANSI INCITS 397-2005, AT Attachment with Packet Interface-7 standard.

Table 2: ATA Modes of Operation

Mode	Support
PIO	0, 1, 2, 3, 4
Multiword DMA	0, 1, 2
Ultra DMA	0, 1, 2, 3, 4, 5

2.3 Performance

Tables 3 and 4 show the performance specifications, which are based on the I25FBS-128GC33N.

2.3.1 Sustained and Random Performance

Table 3: Sustained and Random Read/Write Performance

Parameter	Value
Burst Read	100 MBytes/sec ⁴
Burst Write	100 MBytes/sec
Sustained Read ⁵	Up to 70 MBytes/sec
Sustained Write	Up to 45 MBytes/sec
Random Read ⁶	2750 Input/Output Per Second (IOPS)
Random Write	10 IOPS

2.3.2 Access/Startup Times

Table 4: Access/Startup Performance

Parameter	Value (Typ)
Start Up Time (Reset to Busy)	25 μ secs
Start Up Time (Reset to Not Busy)	3.0 sec
Access Time	< 1 msec
Seek Time	0

⁴ One megabyte, or MByte, equals 1,048,576 bytes.

⁵ Sustained performance values are based on 128 KByte transfers.

⁶ Random performance values are based on 4 KByte transfers.

2.4 Capacity

Table 5 describes the available memory capacities for the XceedSecure2 2.5" PATA SSD.⁷

Table 5: XceedSecure2 2.5" PATA Capacities

Uninitialized Drive Capacity (GBytes)	Shipped Sector Count in LBA Mode ⁸	Cylinder Heads Sectors (CHS)			
		Number of Logical Cylinders	Number of Logical Heads	Logical Sectors Per Track	Current Capacity (CHS)
9.5 mm SSD					
32	60899328	16383	16	63	16514064
64	121847040	16383	16	63	16514064
128	244012608	16383	16	63	16514064

2.5 PATA Bus Characteristics

Table 6: XceedSecure2 2.5" PATA Bus Characteristics

Parameter	Test Conditions	Min	Typ	Max	Units
Voltage Input High (V_{IH})		2.0		5.5	V
Voltage Input Low (V_{IL})				0.8	V
Voltage Output High (V_{OH})	I_{OH} Min	2.4			V
Voltage Output Low (V_{OL})	I_{OL} Min			0.5	V
Driver Sink Current (I_{OL}) ⁹		4.0			mA
Driver Source Current (I_{OH})		0.4			mA

⁷ The ATA specification defines a limited number of bits for the cylinders, heads, and sectors (CHS). When using CHS-mode commands, the host can only access the first 16 GBytes, not the full drive capacity.

⁸ This number does not include the OS file system overhead.

⁹ DASP I_{OL} is 12 mA as indicated in the ATA/ATAPI-7 Specification.

2.6 Supply Voltage

Table 7: XceedSecure2 2.5" PATA SSD Supply Voltage

Parameter	Min	Typ	Max	Units
Supply Voltage (V_{CC})	4.75	5.0	5.25	V

2.7 Power Consumption

Table 8: XceedSecure2 2.5" PATA SSD Power Consumption (I25FBS-128G33N)

Parameter	Maximum		Average		RMS	
	mA	W	mA	W	mA	W
Sustained Read	730	3.7	240	1.2	250	1.8
Sustained Write	770	3.9	250	1.8	270	1.9
Idle	440	2.2	220	1.1	220	1.1
Startup	530	2.7	220	1.1	220	1.1
EraSure® Clear	790	4.0	280	1.4	280	1.4
Fast Clear and Initialize	1190	6.0	320	1.6	350	1.8

Table 9: XceedSecure2 2.5" PATA SSD Power Consumption (I25FBS-64G33N)

Parameter	Maximum		Average		RMS	
	mA	W	mA	W	mA	W
Sustained Read	730	3.7	220	1.1	240	1.2
Sustained Write	790	4.0	240	1.2	260	1.3
Idle	420	2.2	200	1.0	200	1.0
Startup	550	2.8	200	1.0	200	1.0
EraSure® Clear	640	3.2	260	1.3	270	1.9
Fast Clear and Initialize	1100	6.5	260	1.3	280	1.4

Table 10: XceedSecure2 2.5" PATA SSD Power Consumption (I25FBS-32G33N)

Parameter	Maximum		Average		RMS	
	mA	W	mA	W	mA	W
Sustained Read	660	3.3	230	1.2	250	1.3
Sustained Write	770	3.9	290	1.5	320	1.6
Idle	420	2.2	210	1.1	210	1.1
Startup	530	2.7	200	1.0	210	1.1
EraSure® Clear	620	3.1	270	1.9	270	1.9
Fast Clear and Initialize	840	4.2	260	1.3	270	1.4

3.0 RELIABILITY CHARACTERISTICS

Table 11: Reliability Parameters

Parameter	Value
Bit Error Rate	< 1 non-recoverable in 10^{14} bits read
Data Retention	10 years at 25°C
ECC/EDC (Reed-Solomon)	4 bytes correction/5 bytes detection for each 512-byte sector
Write Endurance	> 260 years @ 200 GBytes/day for 64 GBytes ¹⁰

4.0 ENVIRONMENTAL SPECIFICATIONS

4.1 Temperature

Table 12: Reliability Temperatures

Parameter	Min	Typ	Max
Commercial Operating Temperature (T_a)	0°C	25°C	70°C
Industrial Operating Temperature (T_a) ¹¹	-40°C	--	85°C
Storage Temperature ¹¹	-55°C	---	95°C

4.2 Operating Environment

Table 13: Operating Environment

Parameter	Value
Relative Humidity ¹²	5% to 95% non-condensing
Operating Altitude ¹³	24,384 m [80,000 ft]

¹⁰ Based on 128 KByte block transfers and continuous, sequential writes to the drive. The number does not include file system overhead, which may vary depending on the file system. The total life span of the drive depends on both the write endurance numbers and MTBF. One kilobyte, or KByte, equals 1024 bytes.

¹¹ Based on MIL-STD-810D, Methods 501.4 and 502.4 Procedure I.

¹² Based on MIL-STD-810F, Method 507.4

¹³ Based on MIL-STD-810F, Method 500.4 Procedure II.

4.3 Shock and Vibration

Table 14: Shock and Vibration

Parameter	Value
Non-Operating Shock ¹⁴	1500 g half-sine, 0.5ms, 1 shock (+/- each) along the X, Y, and Z axes
Operating Shock ¹⁴	50 g half-sine, 11 ms, 3 shocks (+/- each) along the X, Y, and Z axes
Operating Vibration - Random ¹⁵	Drives are tested along 3-axes, X, Y, Z, in accordance with the following: <ul style="list-style-type: none"> • Category 12 for jets modified to 16.4 g rms, 10-2000 Hz random • Category 12 for jets, 10 g rms • Category 13 for propeller aircraft • Category 14 for helicopters • Category 20 for ground vehicles

4.4 Regulations

Table 15: Regulation Compliances

Regulation	Compliance
EMC/Emissions	EN 55022:1998+A1 & A2; CISPR 22:1997; FCC CFR 47 Part 15 Subpart B:2002
EMC/Immunity	EN 61000-4-2:1995; EN 61000-4-3:1998; EN 55024:1998, CISPR 24:1997
Safety	UL IEC 60950-1:2003; CSA C22.2 No. 60950-1
RoHS	EU Directive 2002/95/EC



¹⁴ Based on MIL-STD-810F, Method 516.5-10 Procedure I (modified).

¹⁵ Based on MIL-STD-810F, Method 514.5 Procedure I (modified for 16.4 g rms jet).

5.0 DRIVE CONFIGURATION

5.1 Pin Configurations

The XceedSecure2 2.5" PATA SSD interface connector pinout is shown in Figure 3. Connector pinout descriptions are detailed in Table 16 and Table 17. For information about connection options, see the *XceedSecure2 2.5" PATA Installation Manual*.

Figure 3: XceedSecure2 2.5" PATA Connection View

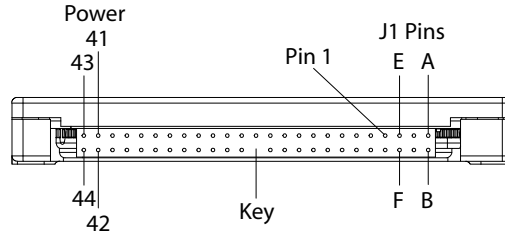

5.1.1 J1 Jumper Settings

Pins A - D configure master, slave, and cable select settings. Pins E and F are used to connect a remote trigger for use in secure erase options. See the following figure for the jumper locations and settings.

Figure 4: J1 Jumper Settings

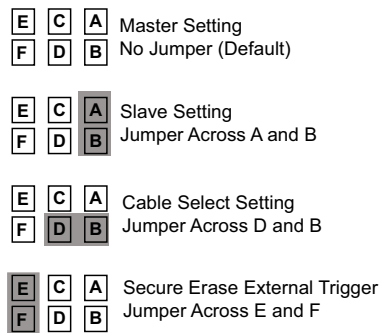

5.1.2 JP1 Jumper Settings

Figure 5 shows the jumper options on the XceedSecure2 2.5" PATA data storage. By default, UDMA and Multiword DMA modes are enabled, and Write Protect is disabled. To disable all DMA modes, place a jumper across pins 2 and 3. To enable Write Protect, place a jumper across pins 1 and 2. Pins 4 and 5 are used to connect a remote trigger for use in secure erase options.

Figure 5: JP1 Jumper Settings

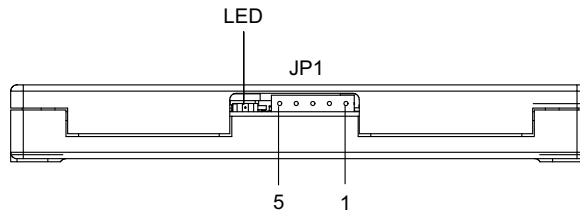

- | | | | | |
|---|---|---|---|---|
| 5 | 4 | 3 | 2 | 1 |
|---|---|---|---|---|

 UDMA and Multiword DMA Enabled
No Jumper (Default)
- | | | | | |
|---|---|---|---|---|
| 5 | 4 | 3 | 2 | 1 |
|---|---|---|---|---|

 Write Protect Enabled
Jumper Across 1 and 2
- | | | | | |
|---|---|---|---|---|
| 5 | 4 | 3 | 2 | 1 |
|---|---|---|---|---|

 All DMA Modes Disabled
Jumper Across 2 and 3
- | | | | | |
|---|---|---|---|---|
| 5 | 4 | 3 | 2 | 1 |
|---|---|---|---|---|

 Secure Erase External Trigger
Jumper Across 4 and 5

5.2 Signal Connector Pinout

Table 16: Signal Connector Pinout

Pin	Signal	Pin	Signal
A	J_-Slave	B	JP_B
C	JP_C	D	J_CSEL_-EN
E	JP_E	F	JP_F
1	-RESET	2	GND
3	DB7	4	DB8
5	DB6	6	DB9
7	DB5	8	DB10
9	DB4	10	DB11
11	DB3	12	DB12
13	DB2	14	DB13
15	DB1	16	DB14
17	DB0	18	DB15
19	GND	20	[KEY]
21	DMARQ	22	GND
23	-DLOW	24	GND
25	-DIOR	26	GND
27	IORDY	28	CSEL
29	-DMACK	30	GND
31	INTRQ	32	-IOCS16
33	DA1	34	-PDIAG
35	DA0	36	DA2
37	-CS0	38	-CS1
39	-DASP	40	GND
41	+5V	42	+5V
43	GND	44	N/C

Signals preceded with a dash (-) are active low as the asserted states. Signals without a dash are asserted high.

5.3 Signal Descriptions

Table 17: Signal Descriptions

Name	Pin(s)	Dir	Description
DA[2:0]	36, 33, 35	I	A2-A0 are used to select one of eight registers in the Task File.
-CS[1:0]	38, 37	I	-CS0 is the chip select for the Task File registers while -CS1 is used to select the Alternative Status Register and the Device Control Register.
CSEL	28	I	This internally pulled-up signal is used to configure this device as a Master or a Slave if J_CSEL_-EN is grounded by a jumper from B to D. When the pin is grounded, this device is configured as a Master. When the pin is open, this device is configured as a Slave.
DB[15:0]	18, 16, 14, 12, 10, 8, 6, 4, 3, 5, 7, 9, 11, 13, 15, 17	I/O	All Task File operations occur in byte mode on the low order bus DD[7:0] while all data transfers are 16-bit using DD[15:0].
-DASP	39	I/O	This input/output is the Disk Active/Slave Present signal in the Master/Slave handshake protocol.
DMARQ	21	O	DMA transfer request.
-DMACK	29	I	DMA request acknowledge.
-DIOW:STOP	23	I	The I/O Write strobe pulse is used to clock I/O data on the card data bus into the drive controller registers when the drive is configured to use the I/O interface. The clocking occurs on the negative to positive edge of the signal (trailing edge). During Ultra DMA, this is the stop signal.
-DIOR: HDMARDY/ HSTROBE	25	I	DIOR is an I/O Read strobe generated by the host. This signal gates I/O data onto the bus from the drive. HDMARDY is the flow control signal for UDMA data-in bursts. HSTROBE is the strobe signal for UDMA data-out bursts.
INTRQ	31	O	Signal used to interrupt host when service is requested.
-IOCS16	32	O	This output signal is asserted low when this device is expecting a word data transfer cycle.
IORDY: DDMARDY/ DSTROBE	27	O	This output signal may be used as IORDY for PIO modes. DDMARDY is the flow control signal for UDMA data-out bursts. DSTROBE is the strobe signal for UDMA data-in bursts.
-PDIAG	34	I/O	This input/output is the Pass Diagnostic signal in the Master/Slave handshake protocol.
-RESET	1	I	This input pin is the active low hardware reset from the host.
GND	2, 19, 22, 24, 26, 30, 40, 43	--	Ground
Key	20	--	This pin is keyed so the drive can only be connected when cable pin 1 aligns with drive pin 1.
J_-SLAVE	A	--	Master/Slave jumper.
J_CSEL_-EN	D	--	When low, CSEL controls Master/Slave.
N/C	44	--	No connect.
+5V	41, 42	--	+5 V
JP_B/JP_C	B, C	--	Reserved for jumpers (not ground).
JP_E/JP_F	E, F	--	Reserved for secure erase functions.

6.0 SUPPORTED ATA COMMANDS

The XceedSecure2 2.5" PATA SSD supports the commands listed in the following table. For a complete description of these commands, see the ATA-7 Standard Specification. Commands listed with an asterisk (*) are blocked if write protect is enabled on the drive.

Table 18: Supported ATA Commands

Command Name	Op Code (Hex)	Command Set (Category)
CFA Write Sectors w/o Erase*	38	CFA
Check Power Mode	E5	PwrMgmt
	98	PwrMgmt
Door Lock	DE	<i>See Media Lock</i>
Door Unlock	DF	<i>See Media Unlock</i>
Execute Device Diagnostic	90	General
Flush Cache	E7	General
Flush Cache Extended	EA	ExtLBA
Identify Device	EC	General
Idle	E3	PwrMgmt
	97	PwrMgmt
Idle Immediate	E1	PwrMgmt
	95	PwrMgmt
Initialize Device Parameters	91	General
Media Lock	DE	Removable Media
Media Unlock	DF	Removable Media
Read Buffer	E4	General
Read DMA	C8	General
Read DMA Ext	25	ExtLBA
Read DMA w/o Retries	C9	General
Read Log Ext	29	ExtLBA
Read Multiple	C4	General
Read Multiple Ext	29	ExtLBA
Read Native Max Address	F8	Protected
Read Native Max Address Ext	27	ExtLBA
Read Sectors	20	General
Read Sectors Ext	24	ExtLBA
Read Sectors w/o Retries	21	General
Read Verify Sectors	40	General
Read Verify Ext	42	ExtLBA
Read Verify w/o Retries	41	General

Table 18: Supported ATA Commands (Continued)

Command Name	Op Code (Hex)	Command Set (Category)
Recalibrate	10	General
	11-1F	General
Security Disable Password*	F6	Security
Security Erase Prepare	F3	Security
Security Erase Unit ¹⁶	F4	Security
Security Freeze Lock	F5	Security
Security Set Password*	F1	Security
Security Unlock	F2	Security
Seek	70	General
	71-7F	General
Set Features	EF	General
Set Max Address	F9	Protected
Set Max Address Ext	37	ExtLBA
Set Multiple Mode	C6	General
Sleep	E6	PwrMgmt
	99	PwrMgmt
S.M.A.R.T. Operations	B0	S.M.A.R.T.
Standby	E2	PwrMgmt
	96	PwrMgmt
Standby Immediate	E0	PwrMgmt
	94	PwrMgmt
Write Buffer*	E8	General
Write DMA*	CA	General
Write DMA Ext*	35	ExtLBA
Write DMA w/o Retries*	CB	General
Write Log Ext*	3F	ExtLBA
Write Multiple*	C5	General
Write Multiple Ext*	39	ExtLBA
Write Sectors*	30	General
Write Sectors Ext*	34	ExtLBA
Write Sectors w/o Retries*	31	General
Write Verify*	3C	General

¹⁶ This command uses a non-standard format which allows the user to select from a different and more comprehensive list of erase sequences than the ATA-7 defines.

7.0 SUPPORTED S.M.A.R.T. OPERATIONS

Self-monitoring analysis and reporting technology (S.M.A.R.T.) commands provide diagnostic information regarding drive operation and, in certain cases, can assist in predicting drive degradation. Because S.M.A.R.T. alerts the host of possible drive problems, you can assess the situation and back up data prior to an operational failure.

Each S.M.A.R.T. attribute monitors a specific drive condition, with threshold levels configured for select attributes. When the drive exceeds these thresholds, the S.M.A.R.T. attribute reports the condition. In many cases, exceeding the threshold simply indicates you should monitor the drive more closely. Host systems initiate commands, generated manually or with a third-party diagnostic tool, to monitor S.M.A.R.T. attributes.

Although XceedSecure2 2.5" PATA drives support several S.M.A.R.T. operations, which are subcommands of the S.M.A.R.T. Operations command (see [Table 19](#)), the S.M.A.R.T. Return Status and S.M.A.R.T. Read Data subcommands are used for monitoring the drive.

Initiating a S.M.A.R.T. Return Status command returns the current state of the drive, specifying "passed" or "failed." A failed status indicates the drive has experienced an "actual" or "predictive" failure. Actual failures are returned when the drive is no longer usable, whereas a predictive failure means the drive has exceeded a threshold level and should be monitored more closely.

The S.M.A.R.T. Read Data command reads the following data from the S.M.A.R.T. attribute table (see [Table 20](#) for a description of the raw data returned for each attribute):

- Power-On Time
- Secure Erase Progress
- Minimum Spares
- Temperature

NOTE:

The S.M.A.R.T. Return Status command does not indicate the attribute that caused the failure. To determine which attribute exceeded the threshold, issue the S.M.A.R.T. Read Data command. For more details, ask your representative for the *S.M.A.R.T. Attributes Technical Reference* for XceedSecure2 drives.

Table 19: Supported S.M.A.R.T. Subcommands

Subcommand Name	Feature Code (Hex)
S.M.A.R.T. Read Data	D0
S.M.A.R.T. Read Attribute Thresholds	D1
S.M.A.R.T. Read Log	D5
S.M.A.R.T. Write Log	D6
S.M.A.R.T. Enable Operations	D8
S.M.A.R.T. Disable Operations	D9
S.M.A.R.T. Return Status	DA
Read Configuration Page	E0
Write Configuration Page	E1
Set Passthrough	E2

Table 20: Supported S.M.A.R.T. Attributes

Attribute ID	Name	Description
9	Power-On Time	Indicates the total number of seconds the drive has been operational.
113	Secure Erase Progress	Displays the progress of the secure erase operation if the drive is currently executing a sequence.
130	Minimum Spares	Specifies the number of spare blocks remaining as a percentage of the spare blocks in the worst wear-leveling zone.
194	Temperature	Returns the drive temperature in degrees Celsius.

8.0 SUPPORTED SECURE ERASE STANDARDS

The EraSure technology supports the secure erase standards listed in the following table. In addition, XceedSecure2 2.5" SATA drives support Fast Clear and Initialize, Clear, and custom secure erase sequences. These sequences can be initiated through either software commands or the external hardware trigger. For more information, see the *EraSure Programmer's Guide*.

Table 21: EraSure Secure Erase Specifications

Agency	Specification
DoD (U.S. Department of Defense, National Security Program Operating Manual)	DoD NISPOM 5220.22-M
DoD (U.S. Department of Defense, National Security Program Operating Manual)	DoD NISPOM 5220.22-M-Sup 1
NSA (U.S. National Security Agency)	NSA/CSS Manual 130-2
NSA (U.S. National Security Agency)	NSA/CSS Manual 9-12
U.S. Army ¹⁷	AR 380-19
U.S. Navy	NAVSO P-5239-26
U.S. Air Force	AFSSI-5020
RCC-TG (Range Commanders Council Telemetry Group)	IRIG 106-07

¹⁷ AR25-2 superseded USA Army 380-19 in 2003. AR25-2 was updated in October 2007, but does not specify a procedure for sanitizing or purging a drive.

9.0 ORDERING INFORMATION

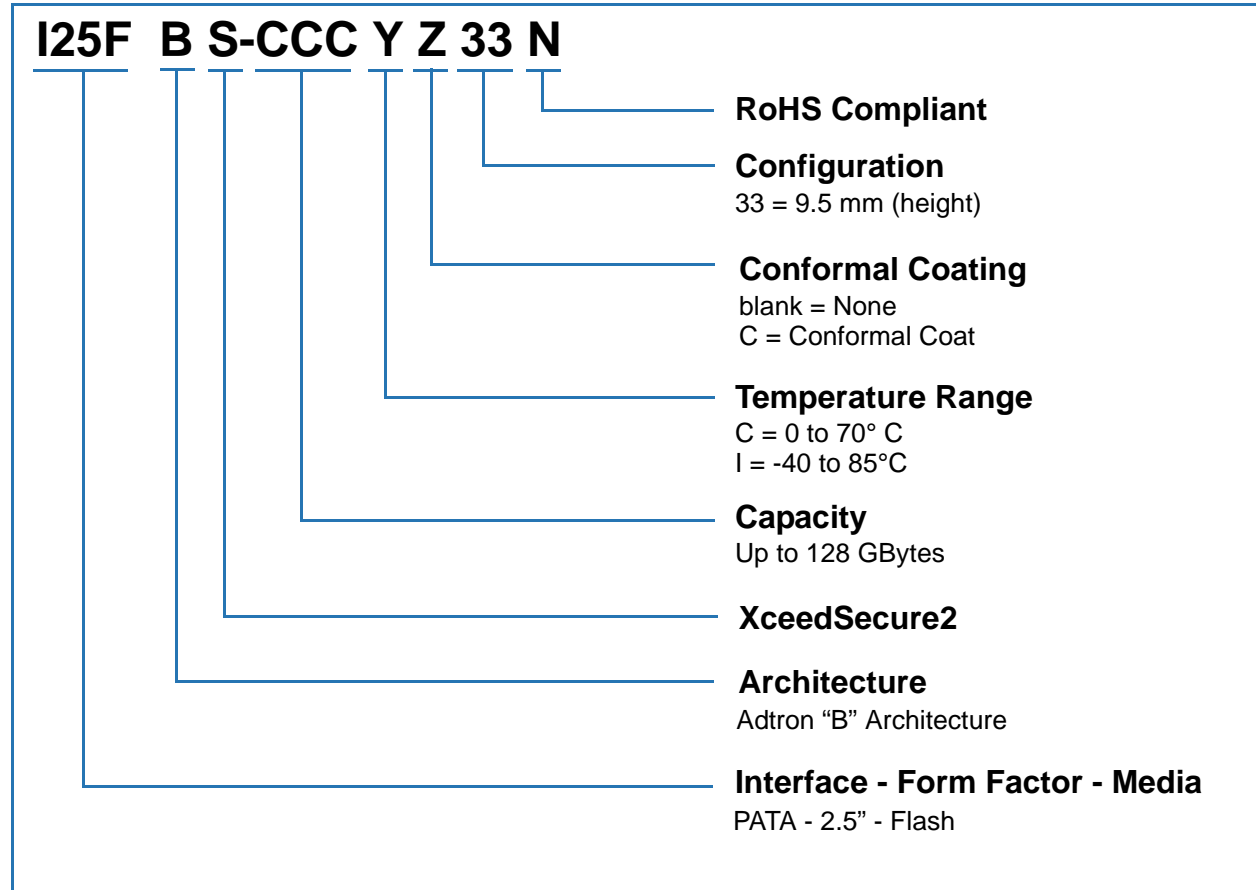

Table 22: Available Model Numbers and Capacities

Model ¹⁸	Capacity (GBytes)	Height (mm)
I25FBS-32GYZ33N (See Above for Y and Z Options)	32	9.5
I25FBS-64GYZ33N (See Above for Y and Z Options)	64	9.5
I25FBS-128GYZ33N (See Above for Y and Z Options)	128	9.5

10.0 RELATED DOCUMENTS

- ATA/ATAPI-7 Standard Specification
- XceedSecure2 2.5" PATA Product Summary
- XceedSecure2 2.5" PATA Installation Manual
- S.M.A.R.T. Attributes Technical Reference (for XceedSecure2 drives)
- EraSure Programmer's Guide

¹⁸ In the model number, "Y" identifies the temperature range of the media (C = Commercial; I = Industrial), and "Z" indicates the conformal coating option (blank = None; C = Conformal Coated).

11.0 CONTACT INFORMATION

SMART Modular Technologies Headquarters

39870 Eureka Dr.
Newark, CA 94560
Tel: (510) 623-1231
Fax: (510) 623-1434
E-mail: fre-info-phx@smartm.com
Web: <http://www.smartm.com>

Adtron Design Center and North American Sales

4415 E. Cotton Center Blvd.
Phoenix, AZ 85040
Tel: (602) 735-0300
Fax: (602) 735-0349
E-mail: fre-sales-phx@smartm.com

International Sales

Phoenix, AZ 85040
Tel: (602) 735-0300
Fax: (602) 735-0349
E-mail: fre-international-phx@smartm.com

Worldwide Technical Support

4415 E. Cotton Center Blvd.
Phoenix, AZ 85040
Tel: (602) 735-0300
Fax: (602) 735-0349
E-mail: fre-techsupport-phx@smartm.com